

# FAGERHULT

## Zest Basic LED

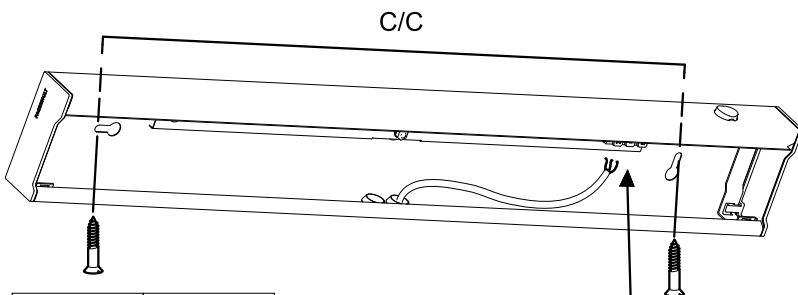

L	C/C
600	596mm
1200	1076mm

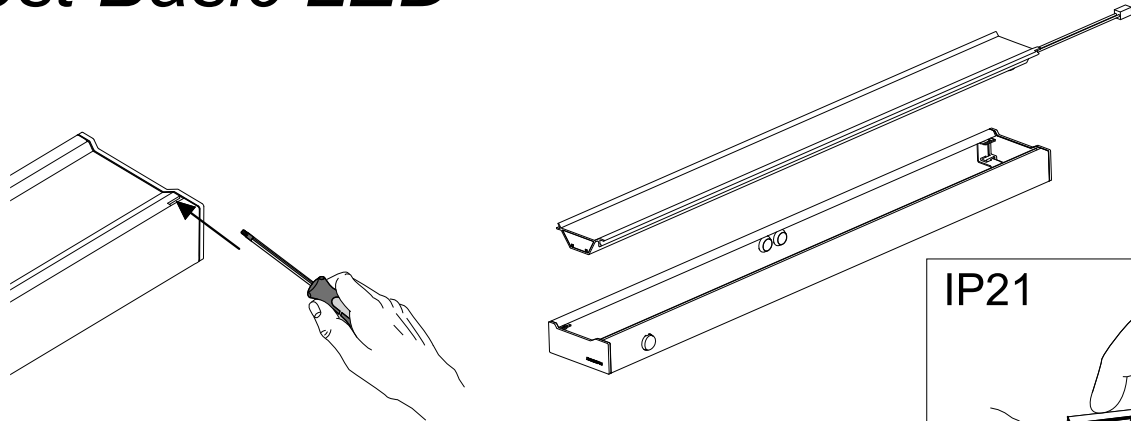
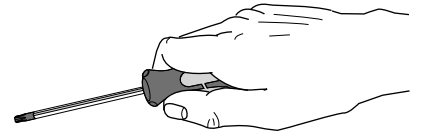
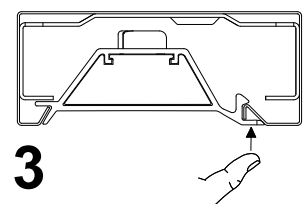
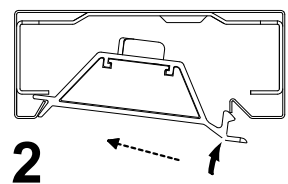
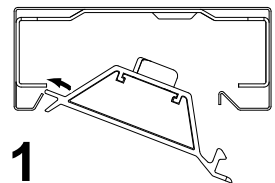
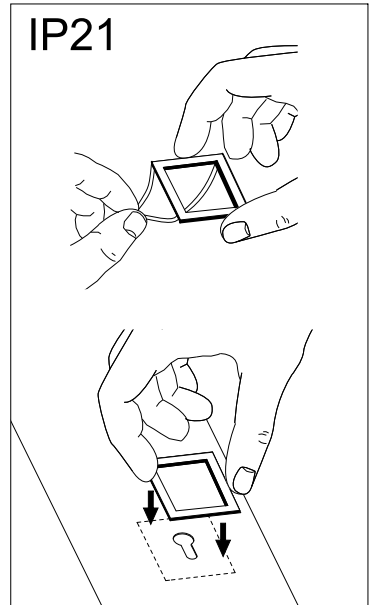
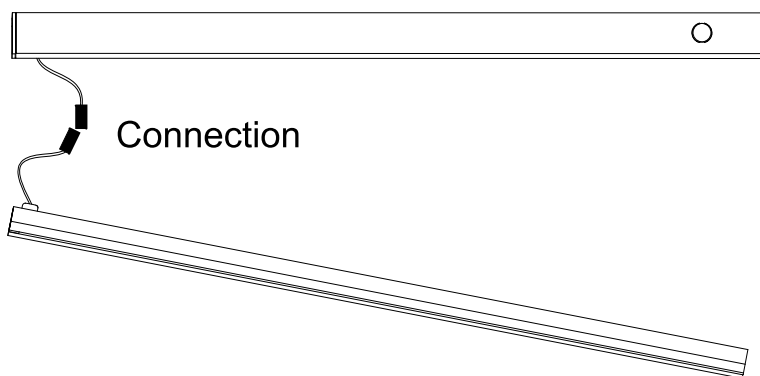
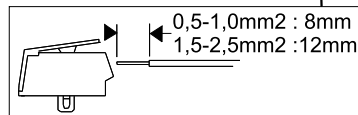

5401493 Utgåva/Edition 01

- (S) Det är lämpligt att denna information överlämnas till användaren av anläggningen. 
 (GB) It is appropriate that this information is passed on to the users of the installation. 
 (CH)
- (D) Diese Informationen sind für den Benutzer der Anlage vorgesehen. 
 (SF) Nämä ohjeet tulee säilyttää ja luovuttaa kiinteistön käyttäjälle.

Fagerhult Lighting System (Suzhou) Co. Ltd  
 No. 11 Workshop 99 Gangtian Road, Suzhou Industrial Park Suzhou 215021, China