

FAGERHULT SE - 566 80 Habo

Notor 65 Control Track Unit

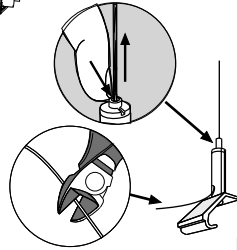

Min 1 susp

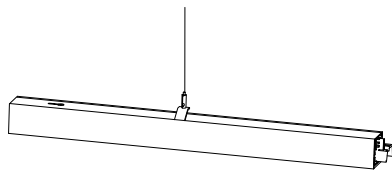
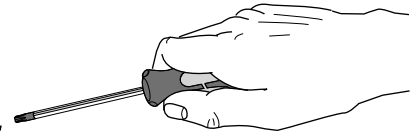
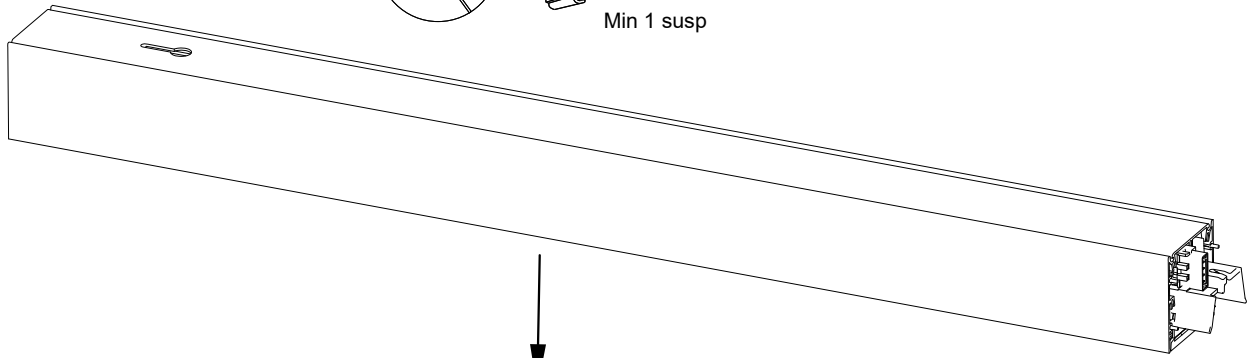

Max 4.5kg

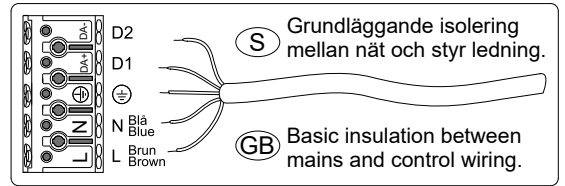
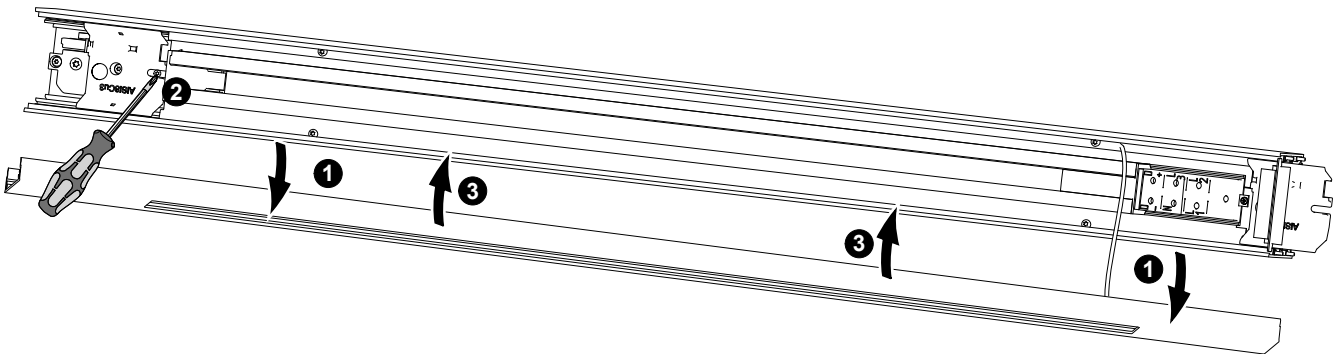
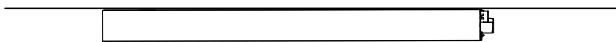

(S) Det är lämpligt att denna information överlämnas till användaren av anläggningen.

(D) Diese Informationen sind für den Benutzer der Anlage vorgesehen.

(GB) It is appropriate that this information is passed on to the users of the installation.

(SF) Nämä ohjeet tulee säilyttää ja luovuttaa kiinteistön käyttäjälle.