

FAGERHULT

SE - 566 80 Habo

Gaudi LED G2

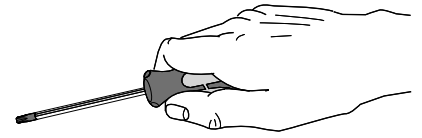

The light source contained in this luminaire shall only be replaced by the manufacturer, his service agent or similar qualified person.

此灯具内的光源应由制造商或其服务代理商或有类似资格的人来更换

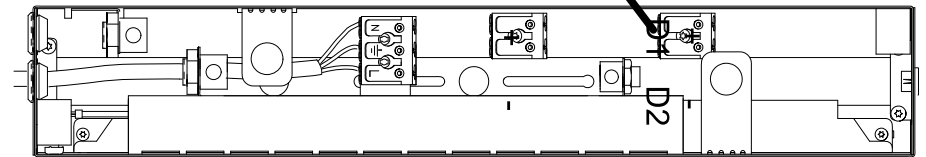
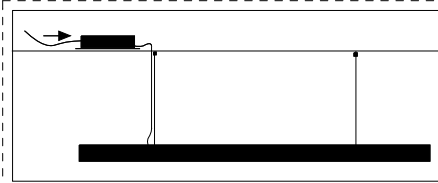
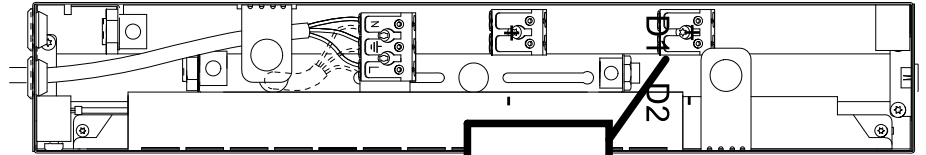
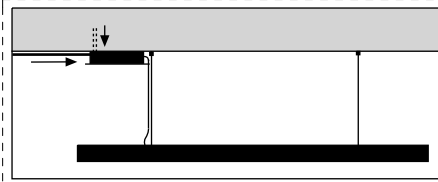
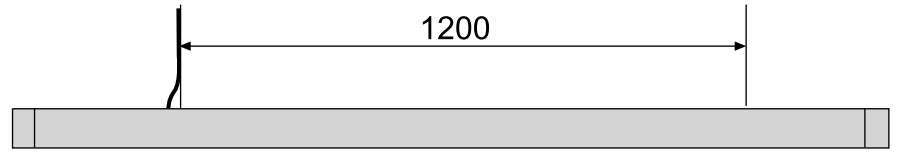

(S) Om den externa flexibla kabeln skulle skadas skall den bytas ut mot en specialkabel eller kabel från tillverkaren eller dess serviceagent.

(GB) If the external flexible cable or cord of this luminaire is damaged, it shall be replaced by a special cord or cord available from the manufacturer or his service agent.

(CH) 如果灯具的外部软缆或软线损坏，该线需由其制造商或服务代理商或有资格的人更换，以免发生危险。

LS
Phase control (impulse)
Faspulskontroll

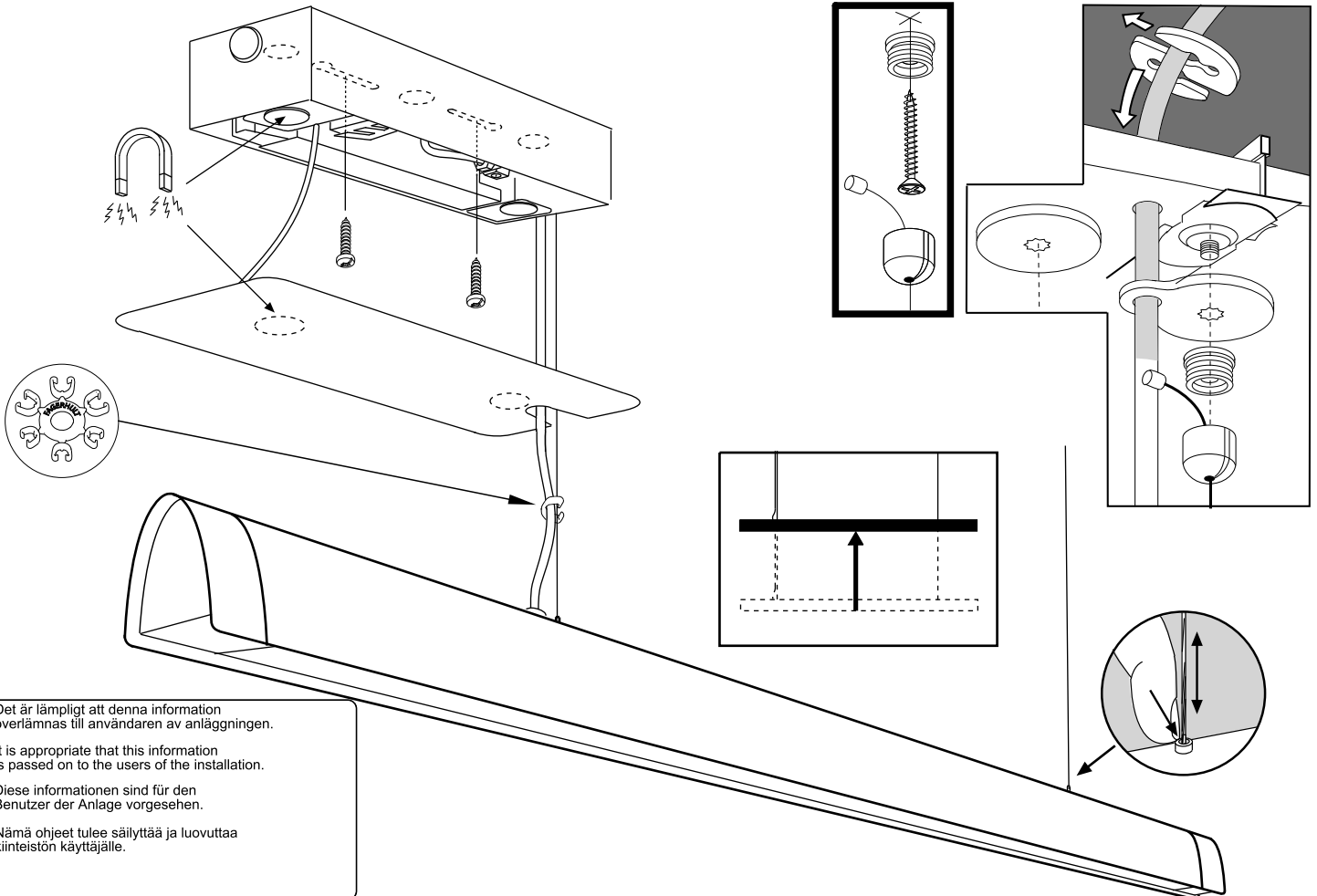
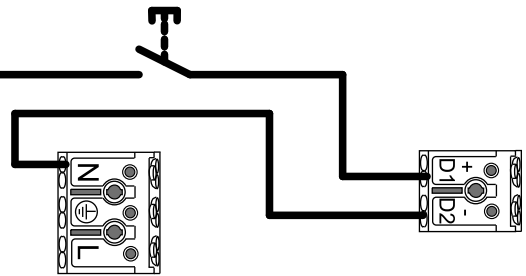

(S) Det är lämpligt att denna information överlämnas till användaren av anläggningen.

(GB) It is appropriate that this information is passed on to the users of the installation.

(D) Diese Informationen sind für den Benutzer der Anlage vorgesehen.

(SF) Nämä ohjeet tulee säilyttää ja luovuttaa kiinteistön käyttäjälle.

(CH)